

Varenummer: 23052321111
Beskrivelse: E+G Fast spændegreb
ERF.44 N-6-C1, Sort

Mål

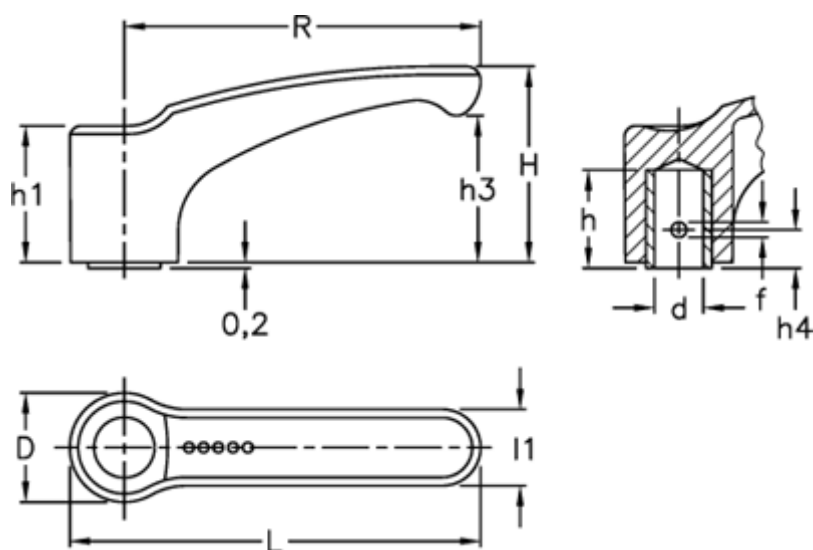

D	= 15.5	L	= 52.0
d H9	= 6	I1	= 11.0
f	= 3	R	= 44
h	= 15		
H	= 26.5		
h1	= 19.0		
h3	= 19.0		
h4	= 7		